

**FEATURES**

- Hermetic glass to metal seal
- High di/dt & dv/dt capabilities.
- Voltage grade upto 2000V

**TYPICAL APPLICATIONS**

- DC Motor control
- Controlled rectifiers
- AC Controllers

**TECHNICAL DATA**

DEVICE TYPE	$V_{DRM}/V_{RRM}$ (V)	$V_{RSM}$ (V)
T500U120	1200	1300
T500U160	1600	1700
T500U200	2000	2100

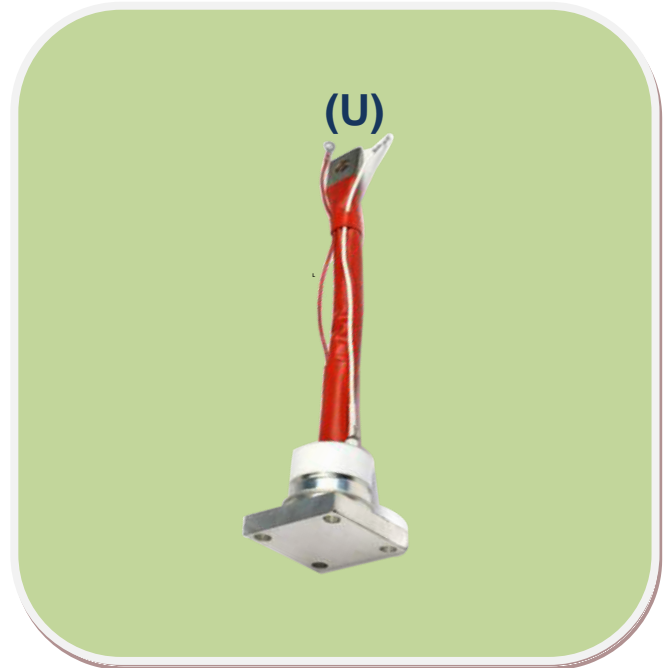

SYMBOL	CONDITIONS	VALUES
$I_{TAV}$	Sin. 180; $T_{case} = 75\text{ }^{\circ}\text{C}$	500 amp.
$I_{RMS}$	$T_a = 45\text{ }^{\circ}\text{C}$	785 amp.
$I_{TSM}$	$T_{vj} = 25\text{ }^{\circ}\text{C}$ ; 10ms	1200 amp.
$I^2t$	$T_{vj} = 25\text{ }^{\circ}\text{C}$	720 $\text{KA}^2\text{S}$
$I_{RRM}/I_{DRM}$	$T_{vj} = 25\text{ }^{\circ}\text{C}$ $T_{vj} = 125\text{ }^{\circ}\text{C}$	15 mA 80 mA
$V_T$	$T_{vj} = 25\text{ }^{\circ}\text{C}$ ( $I_T = 1600\text{ Amp.}$ ); max	1.60 V
di/dt		100A/us
dv/dt		500V/us
$I_{GT}$	$T_{vj} = 25\text{ }^{\circ}\text{C}$	250 mA
$V_{GT}$	$T_{vj} = 25\text{ }^{\circ}\text{C}$	3.0 V
$I_H$	$T_{vj} = 25\text{ }^{\circ}\text{C}$ Typical value	600 mA
$I_L$	$T_{vj} = 25\text{ }^{\circ}\text{C}$ Typical value	1000 mA
$R_{th(j-c)}$	Junction to case	0.07 $^{\circ}\text{C}/\text{W}$
$R_{th(c-h)}$	case to heat sink	0.015 $^{\circ}\text{C}/\text{W}$
$T_{vj}$		125 $^{\circ}\text{C}$
$T_{stg}$		125 $^{\circ}\text{C}$
Mounting torque		10 Nm
Weight	Approx.	900 gm
Package Outline		U

**On State Power Loss**

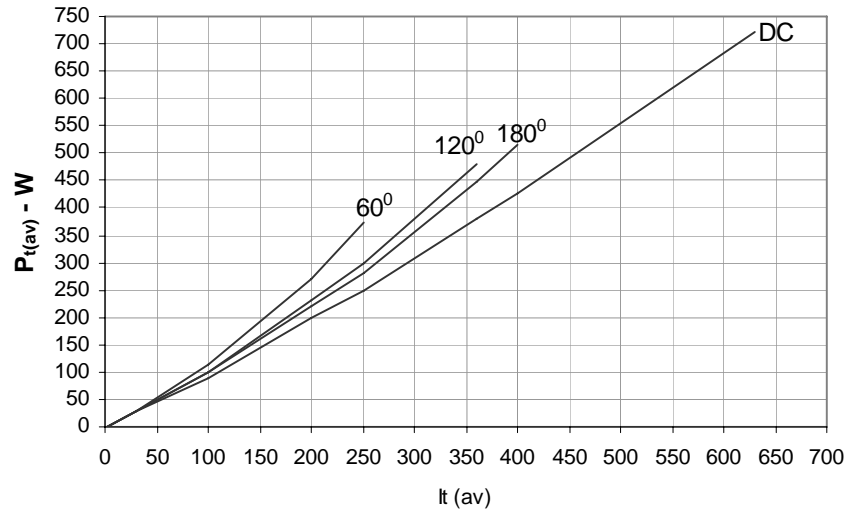

**Maximum Permissible Case Temp**

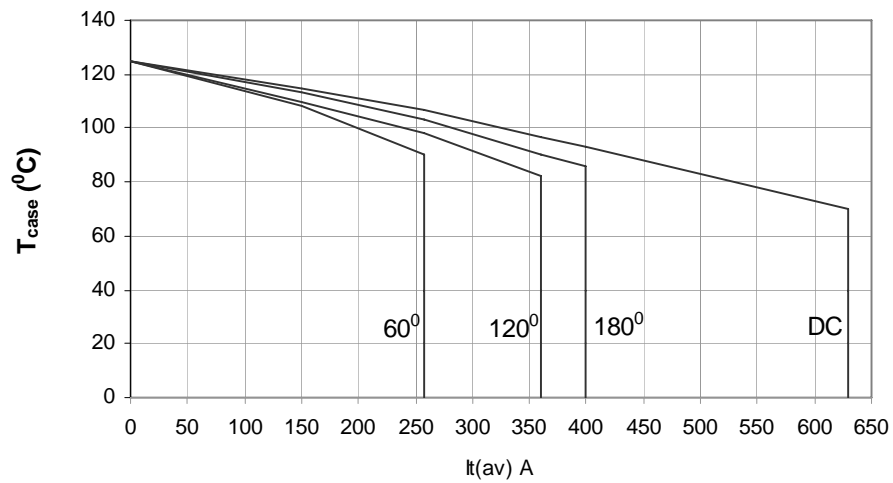

**Max non repetitive Surge Current**

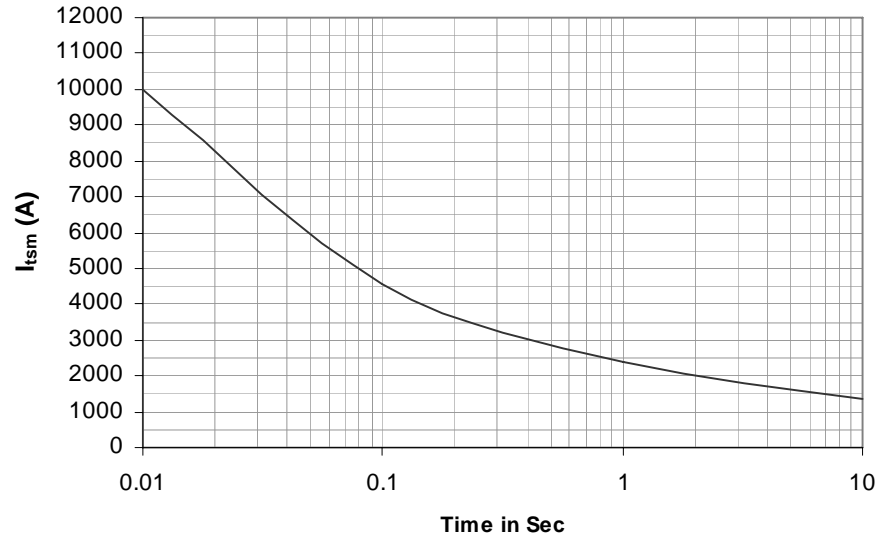

**Transient Thermal Impedance Junction to Case**

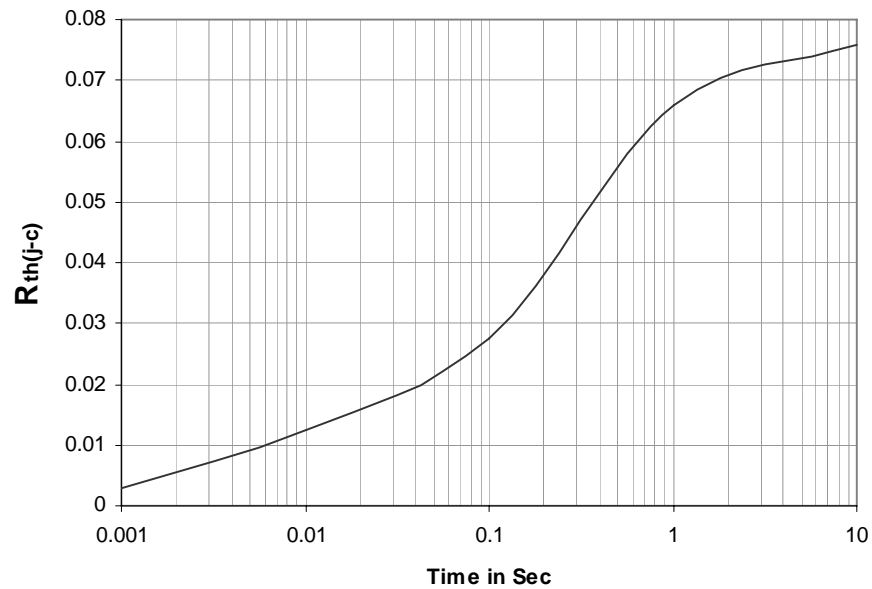

**On State Characteristics**

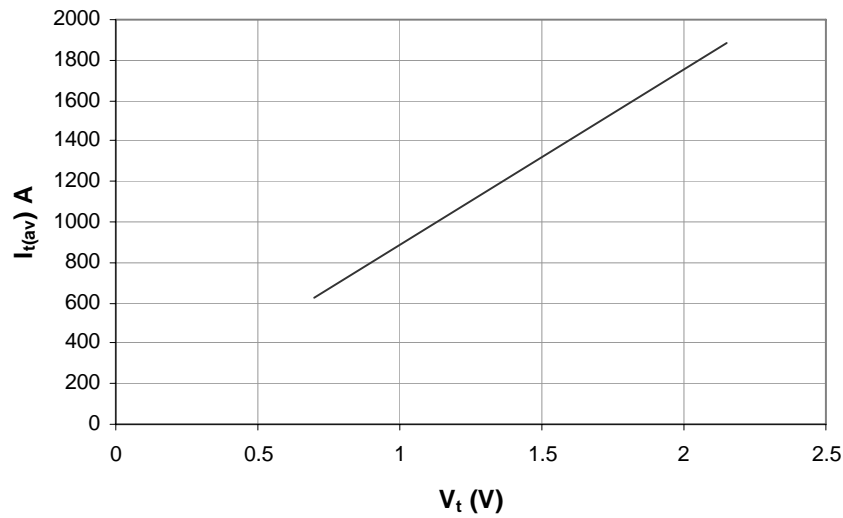

**Gate Trigger Characteristics**

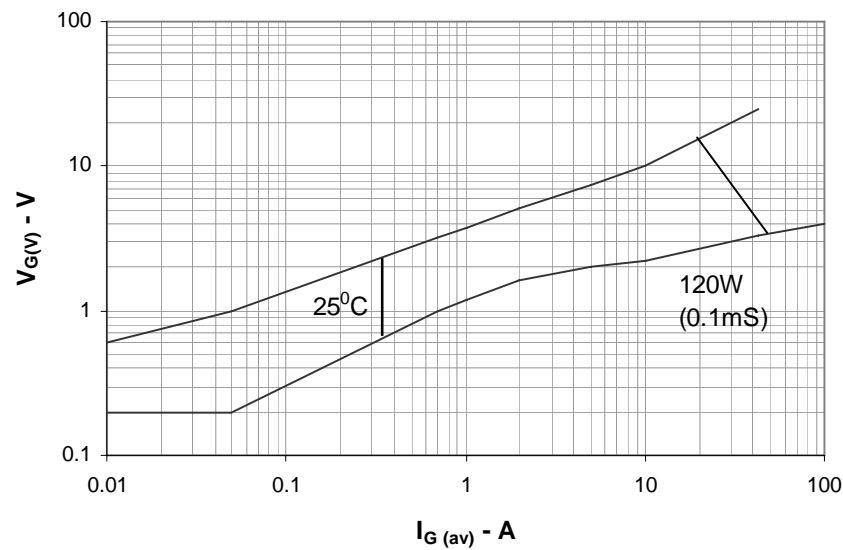

**PACKAGE OUTLINE**

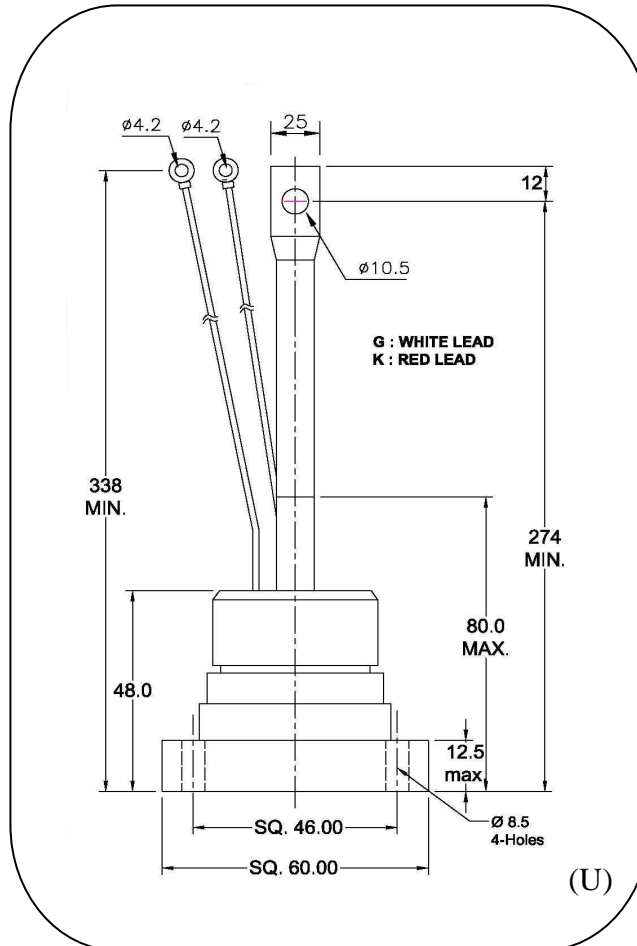

All dimension are in mm .

**Insel Rectifiers (India) Pvt. Ltd.**

(An ISO 9001:2015, ISO 14001:2015 Certified Company)

Plot No 151, Udyog Kendra, Extn.-II, Ecotech-III, Greater Noida-201306

Toll Free No.: 1800 3070 9989, Fax : 011-27491404

E-mail : [insel@rectifierindia.com](mailto:insel@rectifierindia.com), [sales@rectifierindia.com](mailto:sales@rectifierindia.com)