

FEATURES

- Hermetic glass to metal seal
- High di/dt & dv/dt capabilities.
- Voltage grade upto 1600V

TYPICAL APPLICATIONS

- DC Motor control
- Controlled rectifiers
- AC Controllers

TECHNICAL DATA

DEVICE TYPE	V_{DRM}/V_{RRM} (V)	V_{RSM} (V)
T160E120	1200	1300
T160E160	1600	1700



SYMBOL	CONDITIONS	VALUES
I_{TAV}	Sin. 180; $T_{case} = 85\text{ }^{\circ}\text{C}$	170 amp.
I_{RMS}	$T_a = 45\text{ }^{\circ}\text{C}$	270 amp.
I_{TSM}	$T_{vj} = 25\text{ }^{\circ}\text{C}$; 10ms	4650 amp.
I^2t	$T_{vj} = 25\text{ }^{\circ}\text{C}$	105 KA^2S
I_{RRM}/I_{DRM}	$T_{vj} = 25\text{ }^{\circ}\text{C}$ $T_{vj} = 125\text{ }^{\circ}\text{C}$	5 mA 30 mA
V_T	$T_{vj} = 25\text{ }^{\circ}\text{C}$ ($I_T = 500\text{ Amp.}$); max	1.75 V
di/dt		1000 A/us
dv/dt		500V/us
I_{GT}	$T_{vj} = 25\text{ }^{\circ}\text{C}$	150 mA
V_{GT}	$T_{vj} = 25\text{ }^{\circ}\text{C}$	3.0 V
I_H	$T_{vj} = 25\text{ }^{\circ}\text{C}$ Typical value	300 mA
I_L	$T_{vj} = 25\text{ }^{\circ}\text{C}$ Typical value	600 mA
$R_{th(j-c)}$	Junction to case	0.105 $^{\circ}\text{C/W}$
$R_{th(c-h)}$	case to heat sink	0.04 $^{\circ}\text{C/W}$
T_{vj}		125 $^{\circ}\text{C}$
T_{stg}		125 $^{\circ}\text{C}$
Mounting torque		30 Nm
Weight	Approx.	280 gm
Package Outline		E

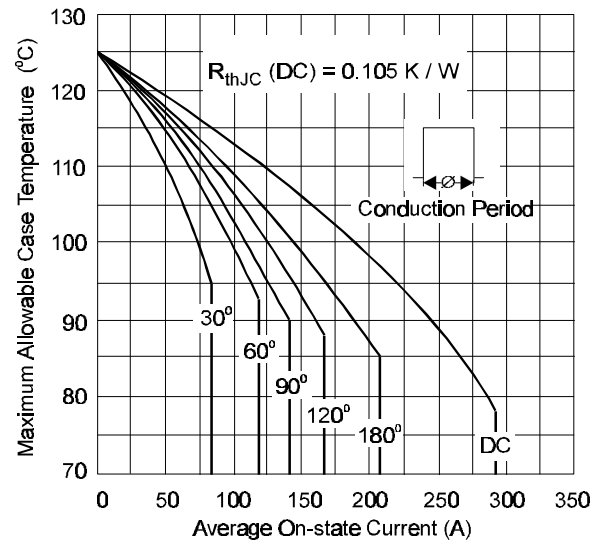
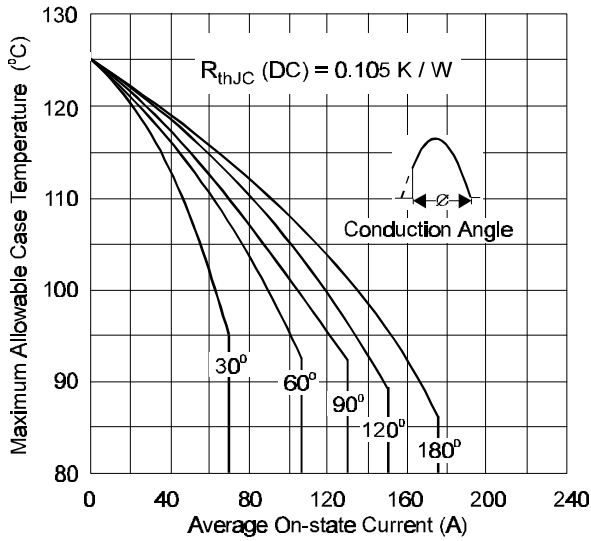

Fig. 1 - Current Ratings Characteristics

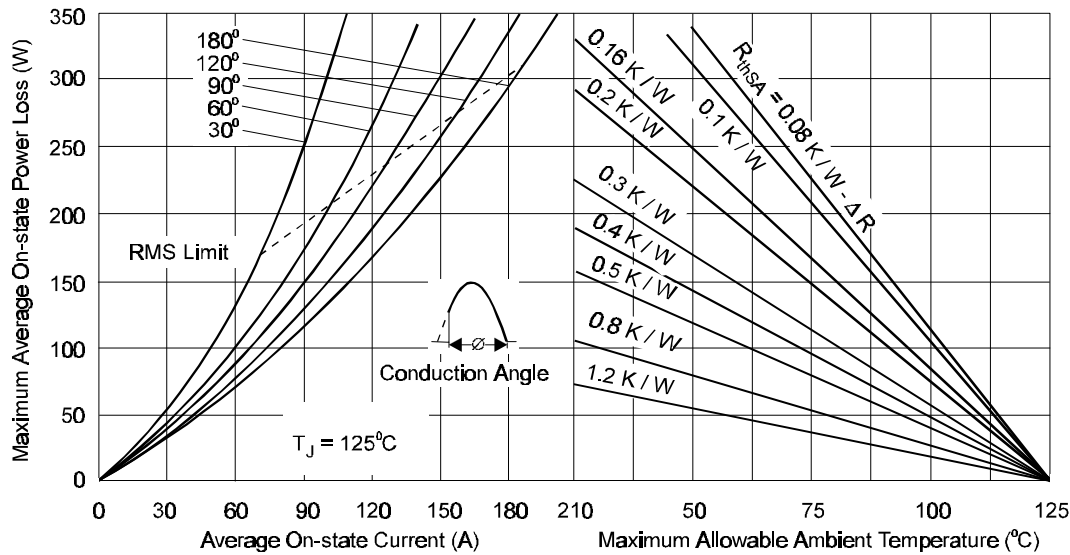

Fig. 3 - On-state Power Loss Characteristics

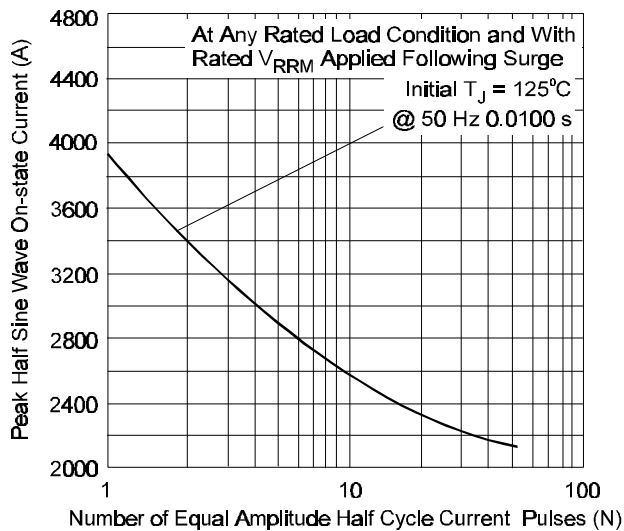
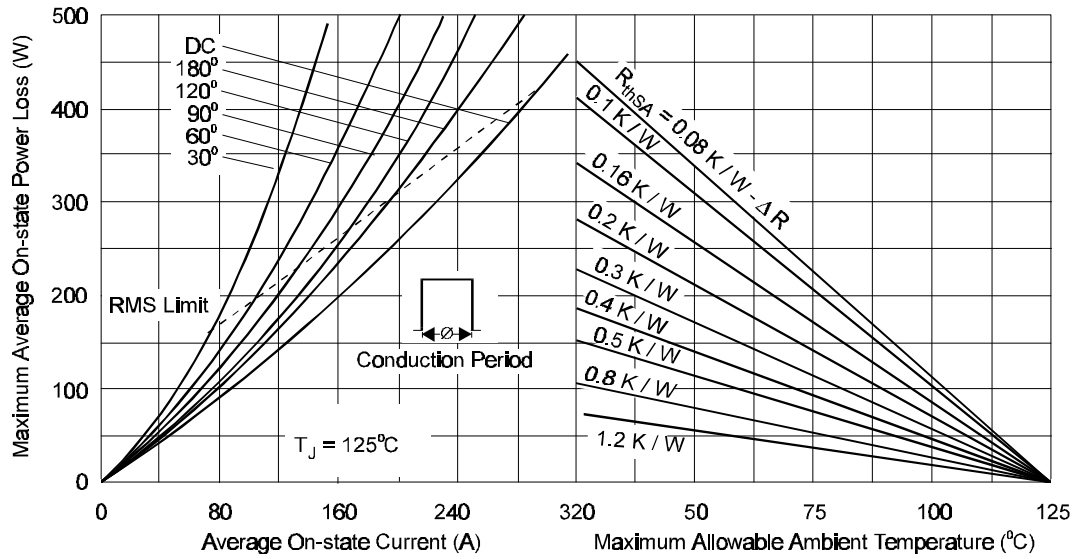

Fig. 7 - Maximum Non-Repetitive Surge Current

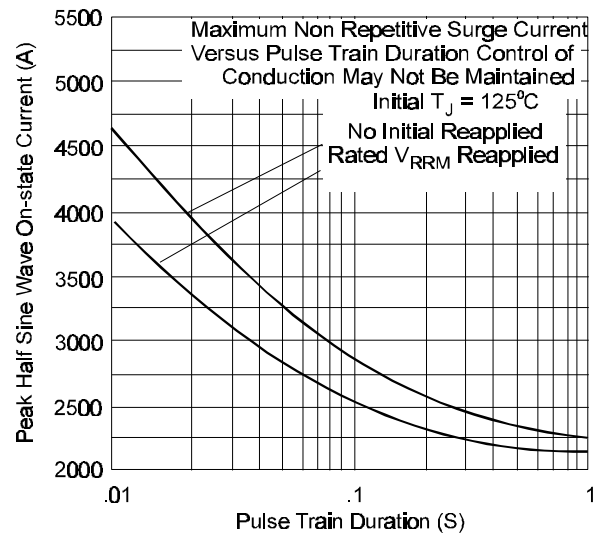

Fig. 9 - Maximum Non-Repetitive Surge Current

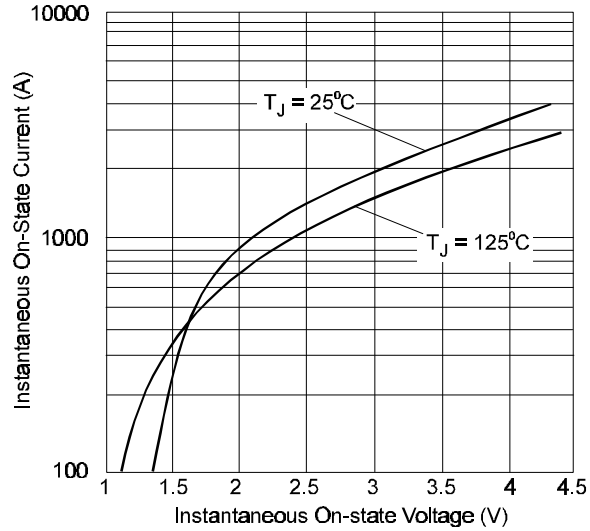

Fig. 11 - On-state Voltage Drop Characteristics

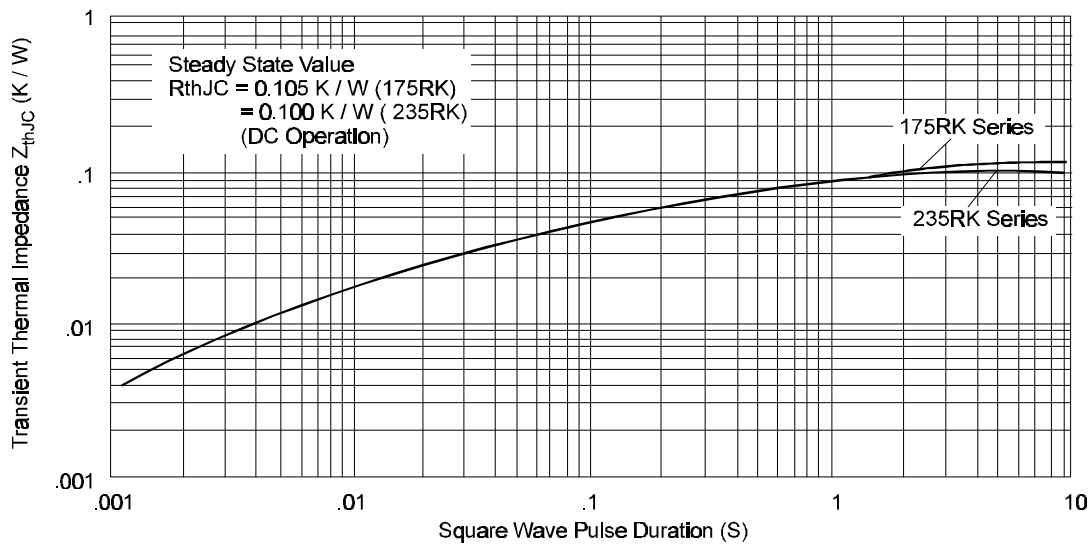

Fig. 13 - Thermal Impedance Z_{thJC} Characteristics

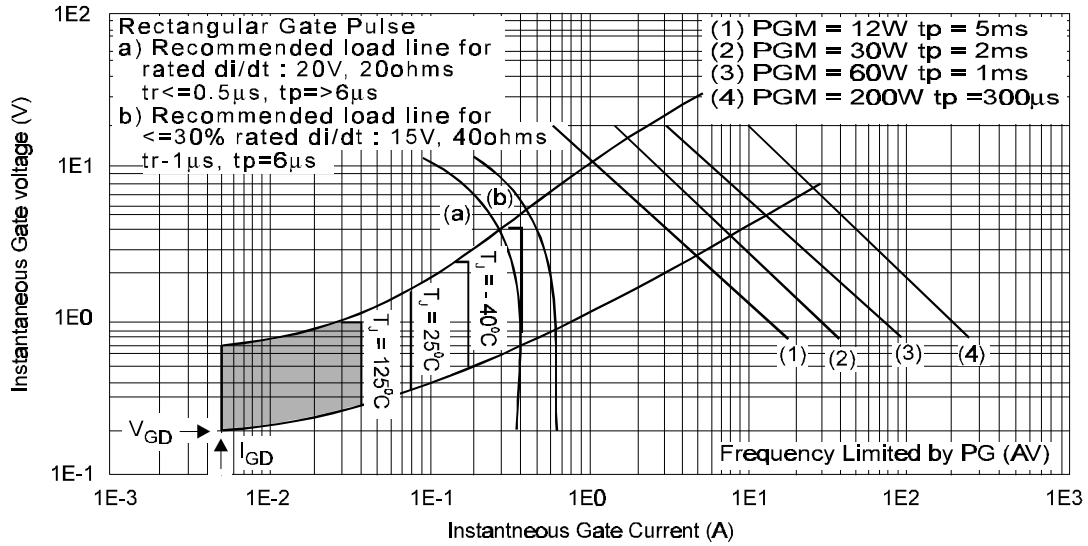
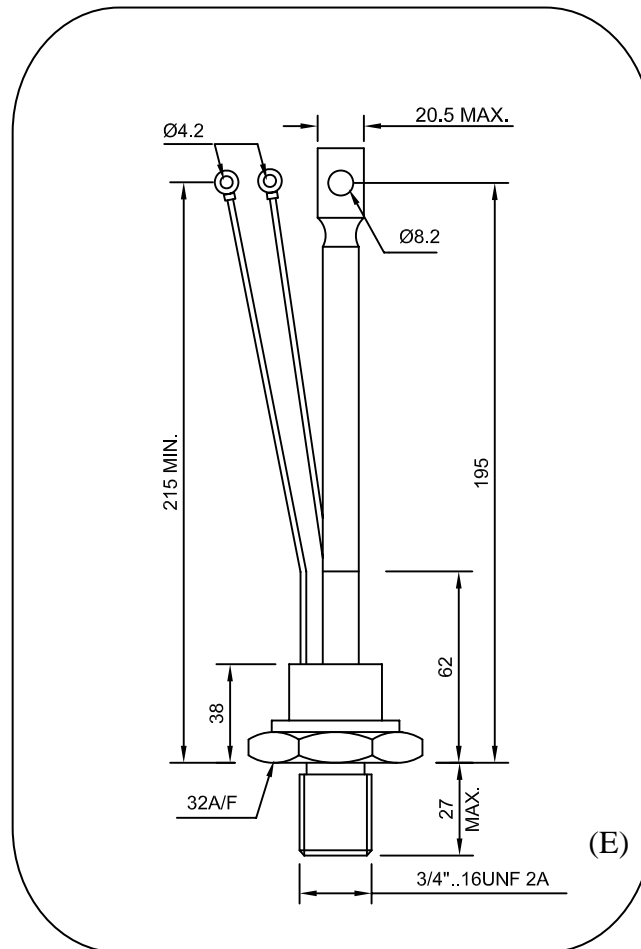

Fig. 9 - Gate Characteristics

PACKAGE OUTLINE



All dimension are in mm .

Insel Rectifiers (India) Pvt. Ltd.

(An ISO 9001:2015, ISO 14001:2015 Certified Company)

Plot No 151, Udyog Kendra, Extn.-II, Ecotech-III, Greater Noida-201306

Toll Free No.: 1800 3070 9989, Fax : 011-27491404

E-mail : insel@rectifierindia.com, sales@rectifierindia.com