

FEATURES

- Hermetic glass to metal seal
- High di/dt & dv/dt capabilities.
- Voltage grade upto 1600V

TYPICAL APPLICATIONS

- DC Motor control
- Controlled rectifiers
- AC Controllers

TECHNICAL DATA

DEVICE TYPE	V_{DRM}/V_{RRM} (V)	V_{RSM} (V)
T150E120	1200	1300
T150E160	1600	1700



SYMBOL	CONDITIONS	VALUES
I_{TAV}	Sin. 180; $T_{case} = 90\text{ }^{\circ}\text{C}$	150 amp.
I_{RMS}	$T_a = 45\text{ }^{\circ}\text{C}$	235 amp.
I_{TSM}	$T_{vj} = 25\text{ }^{\circ}\text{C}$; 10ms	3000 amp.
I^2t	$T_{vj} = 25\text{ }^{\circ}\text{C}$	75 KA^2S
I_{RRM}/I_{DRM}	$T_{vj} = 25\text{ }^{\circ}\text{C}$ $T_{vj} = 125\text{ }^{\circ}\text{C}$	7 mA 30 mA
V_T	$T_{vj} = 25\text{ }^{\circ}\text{C}$ ($I_T = 470\text{ Amp.}$); max	1.80 V
di/dt		1000 A/us
dv/dt		500V/us
I_{GT}	$T_{vj} = 25\text{ }^{\circ}\text{C}$	150 mA
V_{GT}	$T_{vj} = 25\text{ }^{\circ}\text{C}$	2.9 V
I_H	$T_{vj} = 25\text{ }^{\circ}\text{C}$ Typical value	300 mA
I_L	$T_{vj} = 25\text{ }^{\circ}\text{C}$ Typical value	600 mA
$R_{th(j-c)}$	Junction to case	0.11 $^{\circ}\text{C}/\text{W}$
$R_{th(c-h)}$	case to heat sink	0.04 $^{\circ}\text{C}/\text{W}$
T_{vj}		125 $^{\circ}\text{C}$
T_{stg}		125 $^{\circ}\text{C}$
Mounting torque		30 Nm
Weight	Approx.	280 gm
Package Outline		E

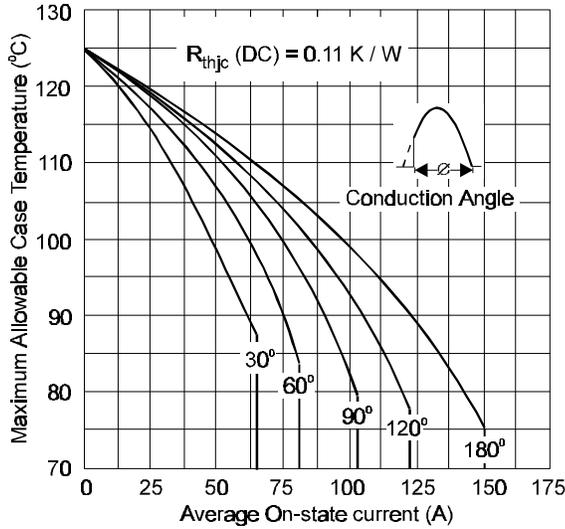

Fig. 1 - Current Ratings Characteristics

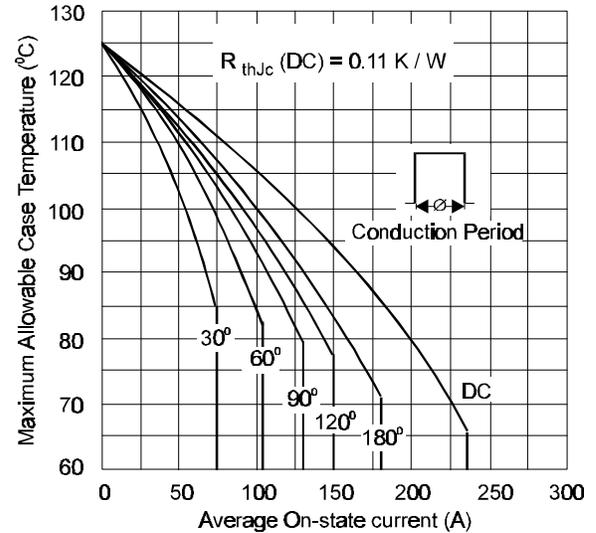

Fig. 2 - Current Ratings Characteristics

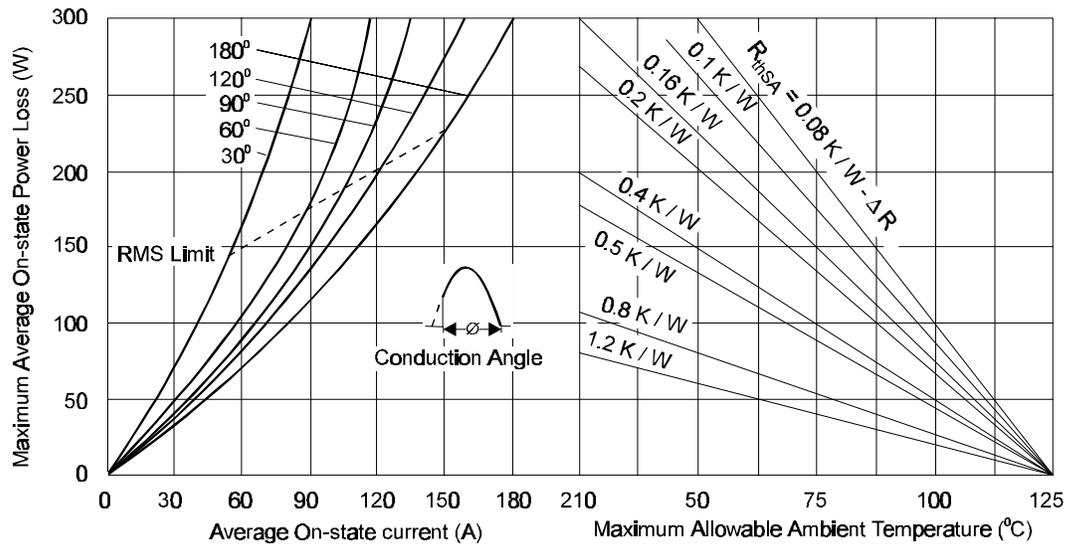

Fig.3 - On-state Power Loss Characteristics

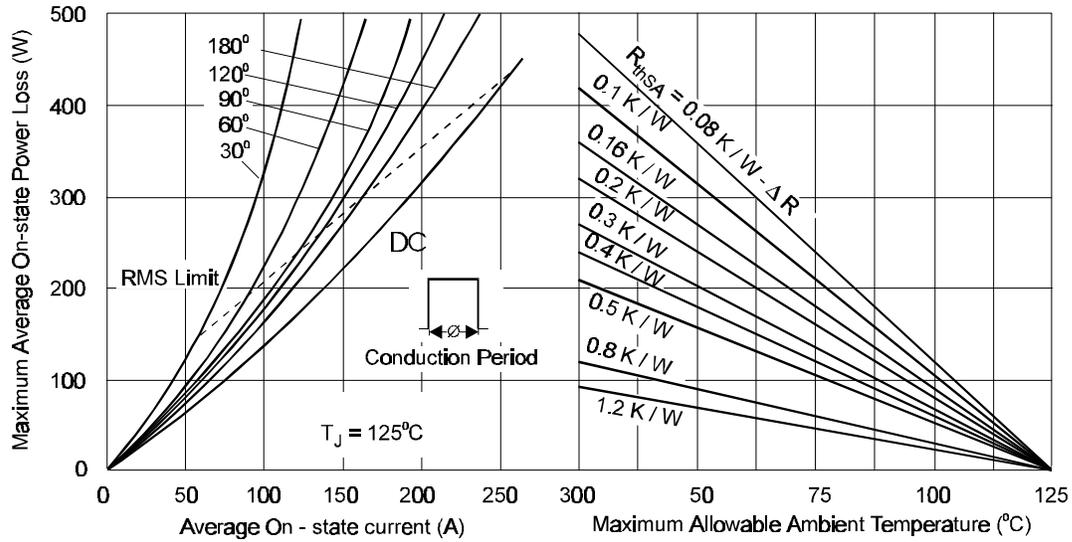

Fig. 4 - On-state Power Loss Characteristics

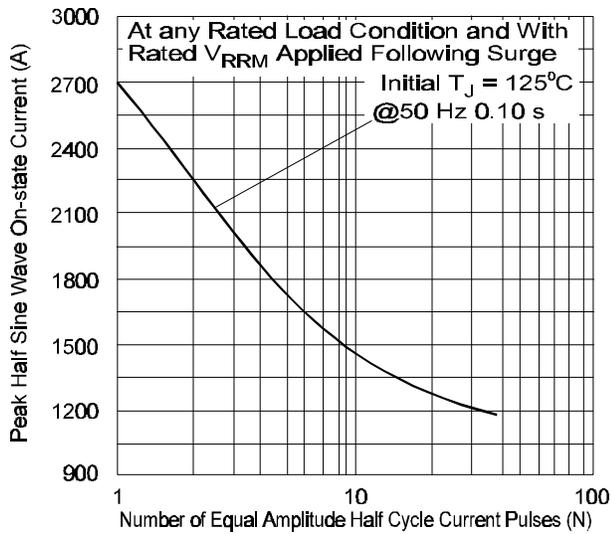

Fig. 5 - Maximum Non-Repetitive Surge Current

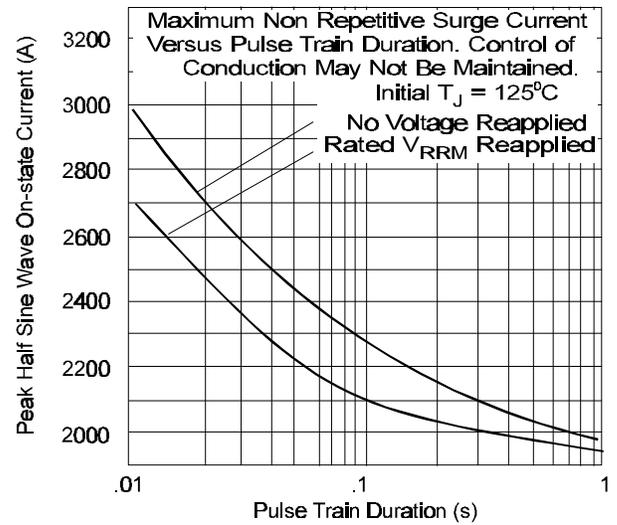

Fig. 6 - Maximum Non-Repetitive Surge Current

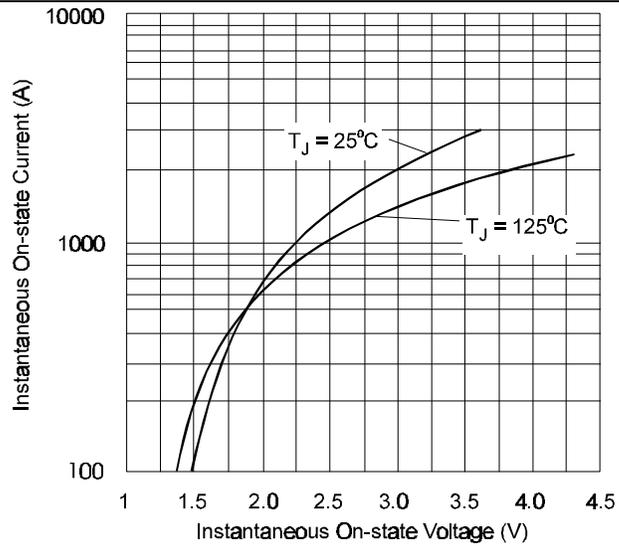

Fig 7 On state Voltage Drop Characteristics

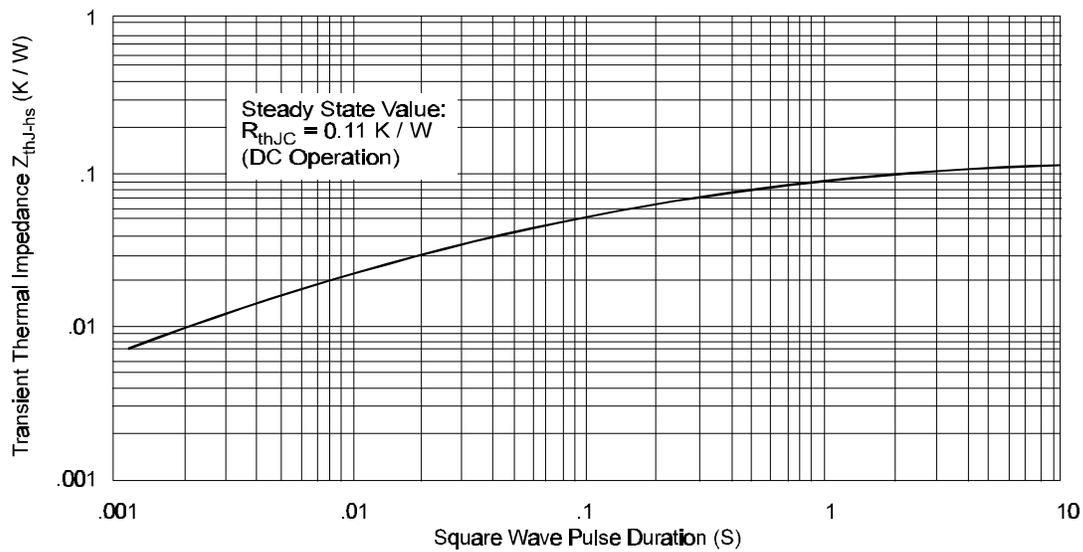

Fig. 8 - Thermal Impedance Z_{thJ-hs} Characteristics

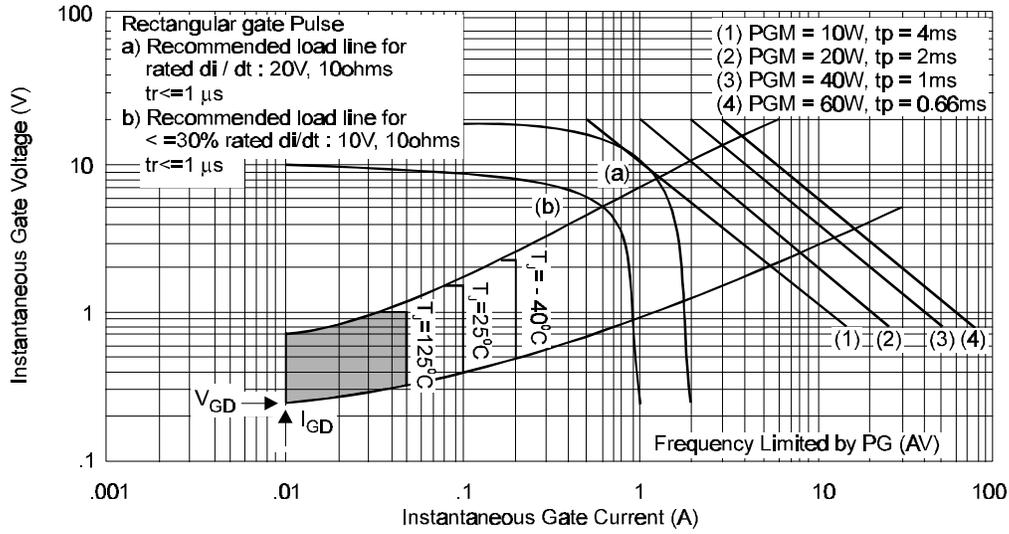
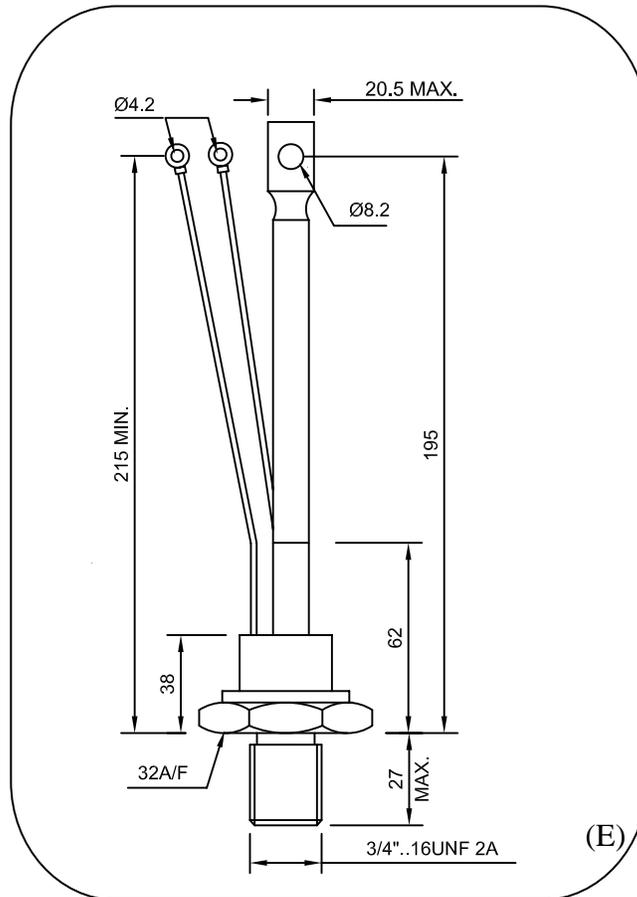

Fig. 9 - Gate Characteristics

PACKAGE OUTLINE



All dimension are in mm .

Insel Rectifiers (India) Pvt. Ltd.

(An ISO 9001:2015, ISO 14001:2015 Certified Company)

Plot No 151, Udyog Kendra, Extn.-II, Ecotech-III, Greater Noida-201306

Toll Free No.: 1800 3070 9989, Fax : 011-27491404

E-mail : insel@rectifierindia.com, sales@rectifierindia.com