

**FEATURES**

- Heat transfer through ceramic.
- Pressure contact for high reliability
- Isolated base mounting

**TYPICAL APPLICATIONS**

- Non-controllable rectifiers for AC-AC converters
- Line rectifiers for transistorized AC motor controllers
- Field supply for DC motor

**TECHNICAL DATA**



DEVICE TYPE	V <sub>RRM</sub> (V)	V <sub>RSM</sub> (V)
<b>IRKD500/12</b>	<b>1200</b>	<b>1300</b>
<b>IRKD500/16</b>	<b>1600</b>	<b>1700</b>
<b>IRKD500/20</b>	<b>2000</b>	<b>2100</b>
<b>IRKD500/22</b>	<b>2200</b>	<b>2300</b>

SYMBOL	CONDITIONS	VALUES
I <sub>FAV</sub>	Sin. 180; T <sub>case</sub> =100°C	500 amp.
I <sub>FSM</sub> I <sup>2</sup> t	Tvj=25°C; 10 ms Tvj=25°C	25000amp. 3125000A <sup>2</sup> S
I <sub>RRM</sub>	Tvj=25°C Tvj=125°C	6 mA 30 mA
V <sub>F</sub> V <sub>0</sub> R <sub>0</sub>	Tvj=25°C (I <sub>F</sub> =2000 Amp.); max Tvj=125°C Tvj=125°C	1.25 V 0.7 V 0.28mΩ
R <sub>th(j-c)</sub> R <sub>th(c-h)</sub> Tvj Tstg	cont.; per diode/per module sin. per diode/per module per diode/per module	0.069/0.034°C/W 0.072/0.036°C/W 0.077/0.038°C/W -40 to +160 °C -40 to +125 °C
Mounting torque		5 Nm/Per bolt
Weight	Approx.	1400 gm
V <sub>(isol)</sub>	Ac 50 Hz rms 1 min	3000 volts
Package Outline		IR-4

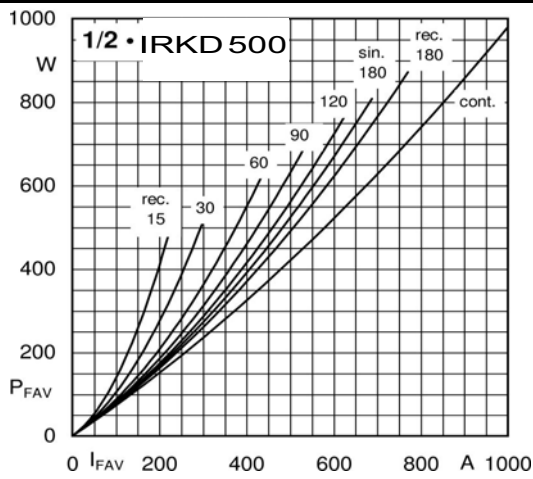

Fig. 11L Power dissipation per diode vs. forward current

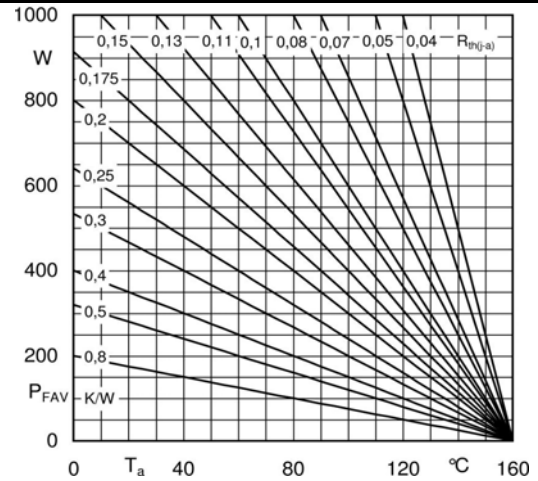

Fig. 11R Power dissipation per diode vs. ambient temperature

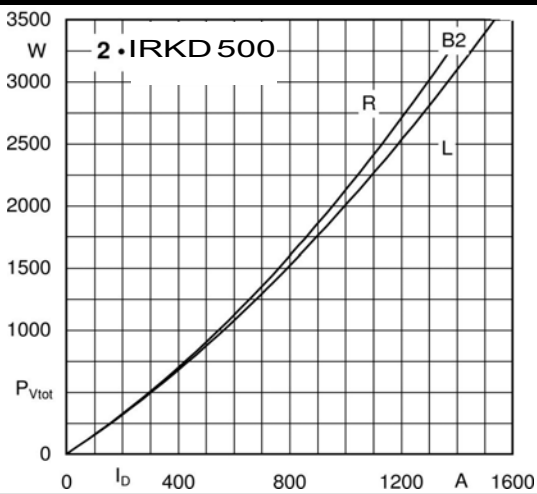

Fig. 12L Power dissipation of two modules vs. direct current

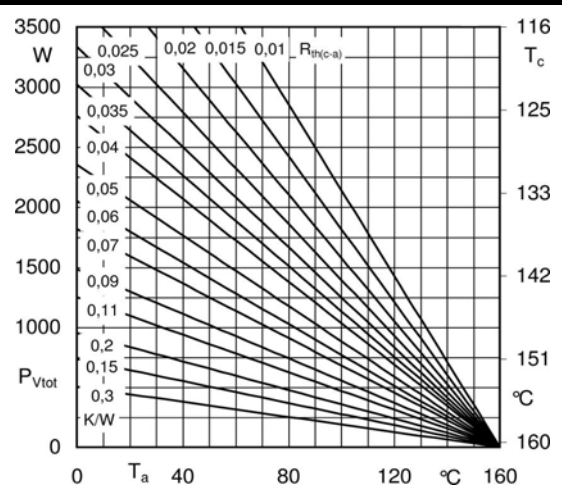

Fig. 12R Power dissipation of two modules vs. case temperature

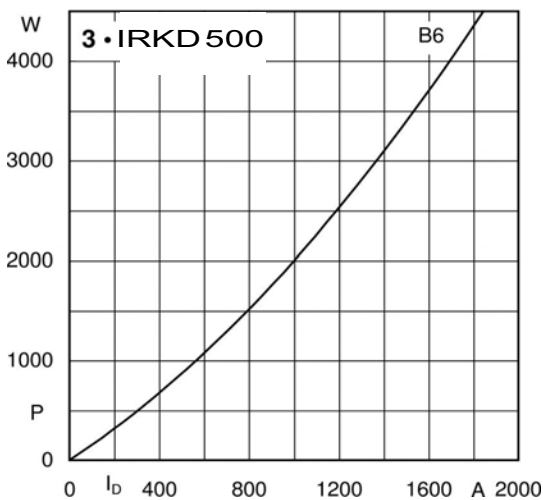

Fig. 13L Power dissipation of three modules vs. direct current

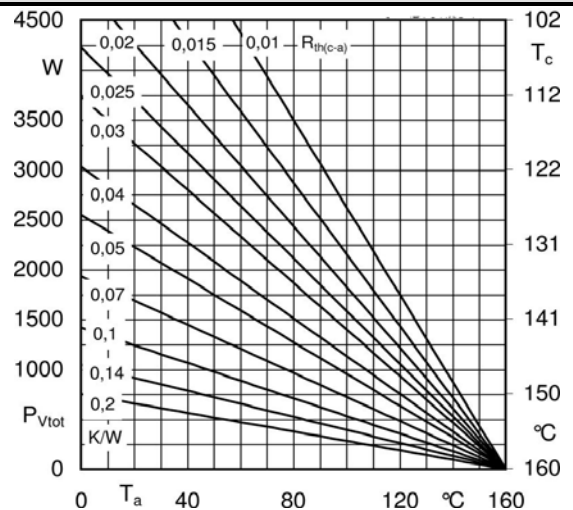

Fig. 13R Power dissipation of three modules vs. case temperature

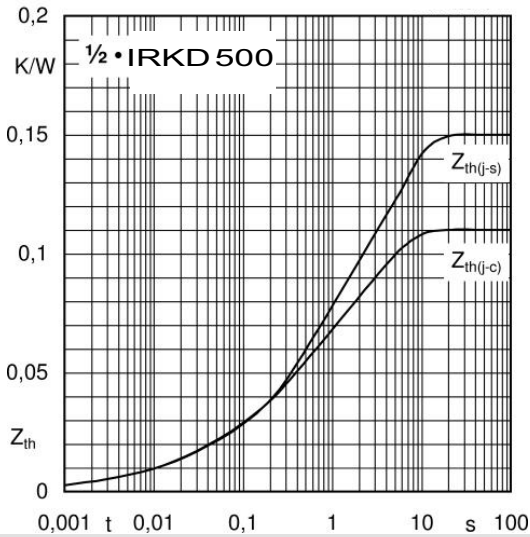

Fig. 14 Transient thermal impedance vs. time

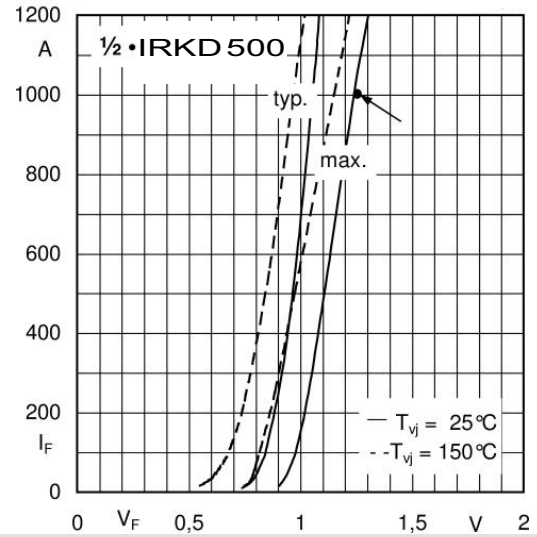

Fig. 15 Forward characteristics

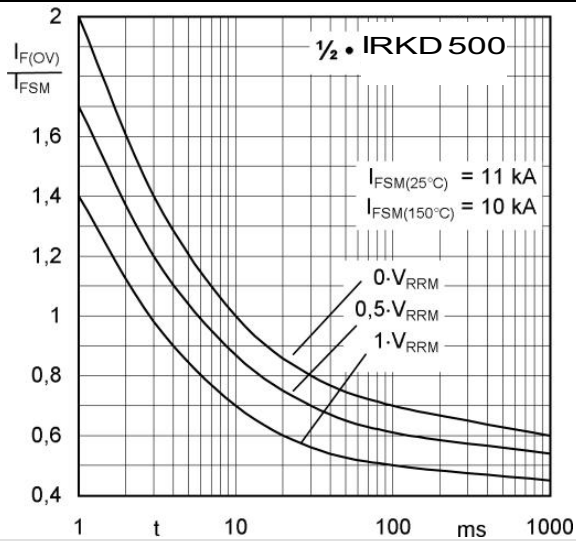
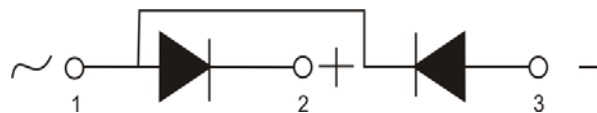

Fig. 16 Surge overload current vs. time

## CIRCUIT DIAGRAM

IRKD 500



**PACKAGE OUTLINE**

IRKD 500

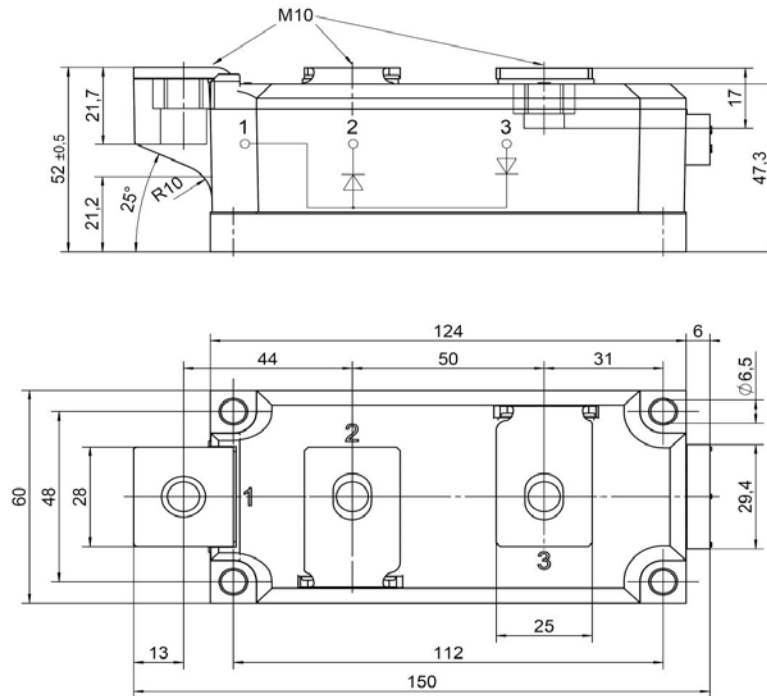

IR- 4

All dimension are in mm .

**Insel Rectifiers (India) Pvt. Ltd.**

(An ISO 9001:2015, ISO 14001:2015 Certified Company)

Plot No 151, Udyog Kendra, Extn.-II, Ecotech-III, Greater Noida-201306

Toll Free No.: 1800 3070 9989, Fax : 011-27491404

E-mail : [insel@rectifierindia.com](mailto:insel@rectifierindia.com), [sales@rectifierindia.com](mailto:sales@rectifierindia.com)