

FEATURES

- Heat transfer through ceramic.
- Hard solder joints for high reliability
- Isolated base mounting

TYPICAL APPLICATIONS

- Non-controllable rectifiers for AC-AC converters
- Line rectifiers for transistorized AC motor controllers
- Field supply for DC motor

TECHNICAL DATA

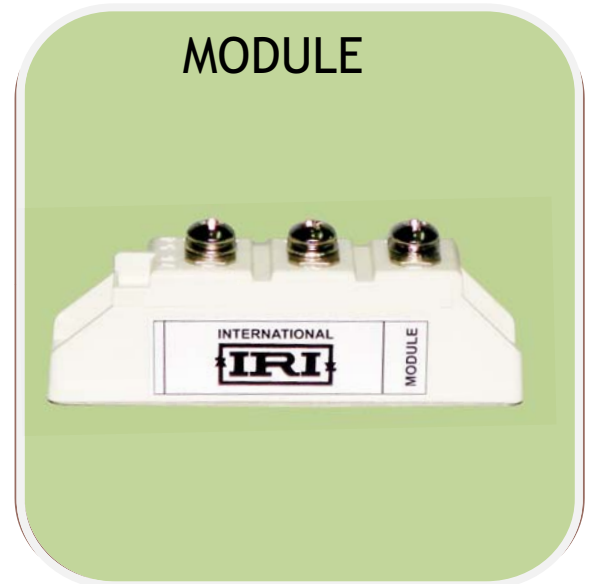

DEVICE TYPE	V_{RRM} (V)	V_{RSM} (V)
IRKD106/12	1200	1300
IRKD106/16	1600	1700
IRKD106/20	2000	2100
IRKD106/22	2200	2300

SYMBOL	CONDITIONS	VALUES
I_{FAV}	Sin. 180; $T_{case} = 85\text{ }^{\circ}\text{C}$	100 amp.
I_{FSM} I^2t	$T_{vj}=25^{\circ}\text{C}$; 10 ms $T_{vj}=25^{\circ}\text{C}$	2500 amp. $31250\text{ A}^2\text{s}$
I_{RRM}	$T_{vj}=25^{\circ}\text{C}$ $T_{vj}=125^{\circ}\text{C}$	1 mA 5 mA
V_F V_0 R_0	$T_{vj}=25^{\circ}\text{C}$ ($I_F=300\text{ Amp.}$); max $T_{vj}=125^{\circ}\text{C}$ $T_{vj}=125^{\circ}\text{C}$	1.35 V 0.85 V 1.3m Ω
$R_{th(j-c)}$ $R_{th(c-h)}$ T_{vj} T_{stg}	per diode/per module per diode/per module	0.35/0.175 $^{\circ}\text{C/W}$ 0.20/0.10 $^{\circ}\text{C/W}$ -40 to +125 $^{\circ}\text{C}$ -40 to +125 $^{\circ}\text{C}$
Mounting torque		5 Nm/Per bolt
Weight	Approx.	95 gms
$V_{(isol)}$	Ac 50 Hz rms 1 min	3000 volts
Package Outline		IR-1

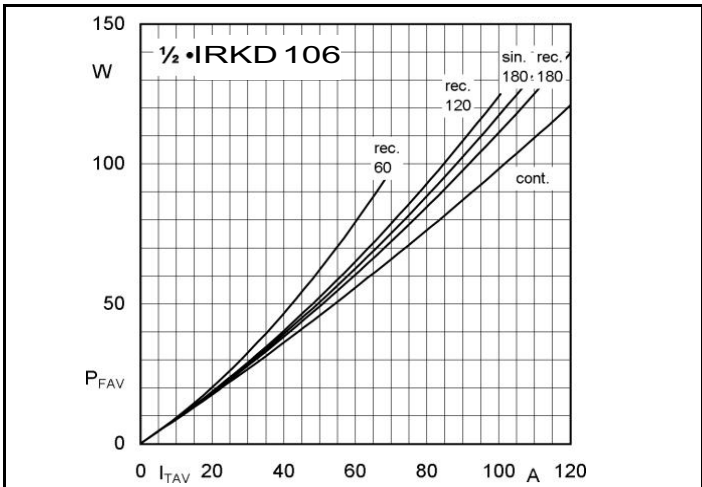

Fig. 11L Power dissipation per diode vs. forward current

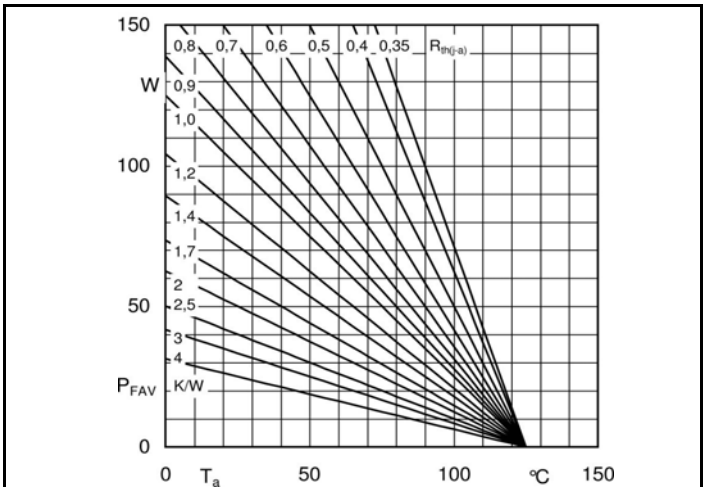

Fig. 11R Power dissipation per diode vs. ambient temperature

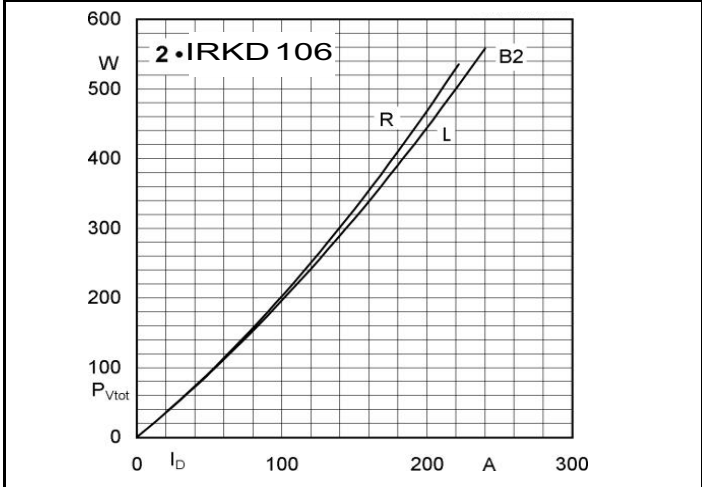

Fig. 12L Power dissipation of two modules vs. direct current

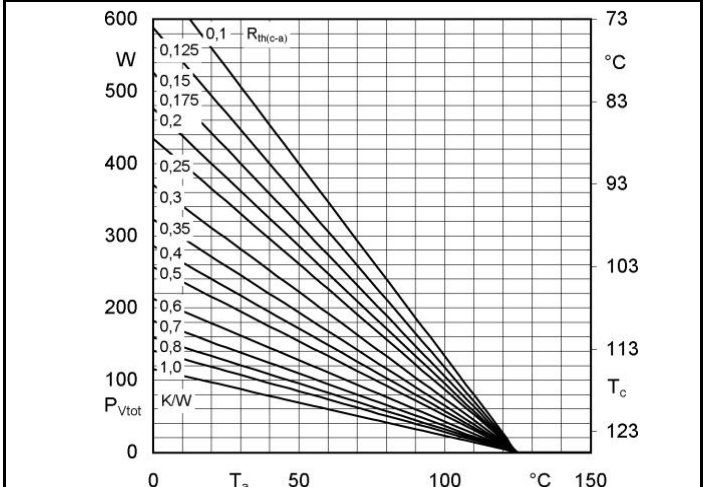

Fig. 12R Power dissipation of two modules vs case temperature

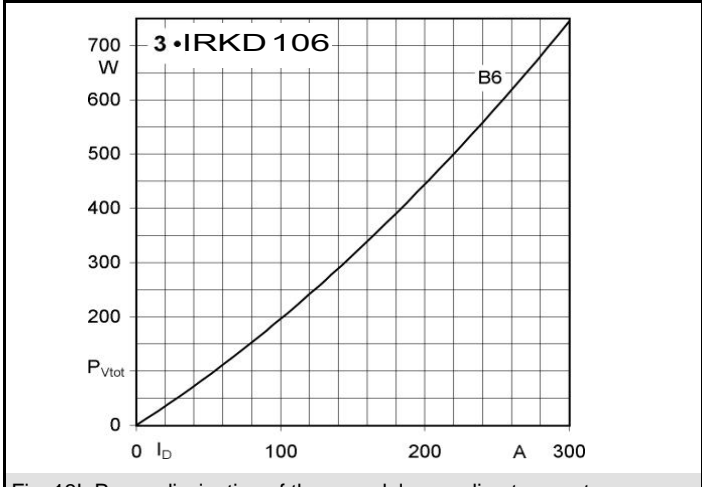

Fig. 13L Power dissipation of three modules vs. direct current

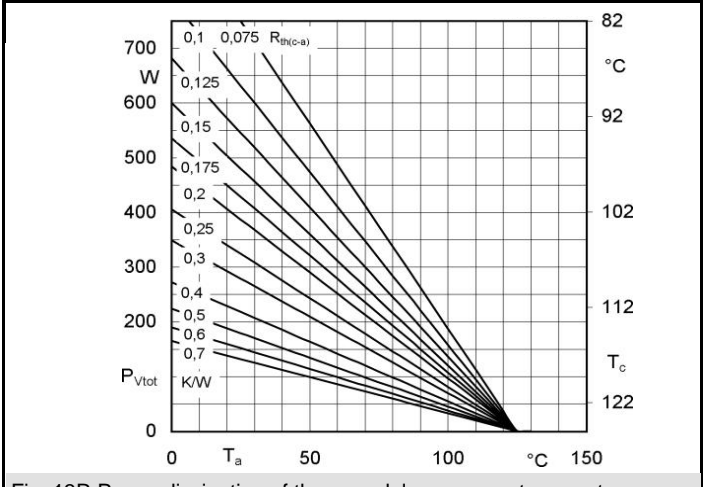

Fig. 13R Power dissipation of three modules vs. case temperature

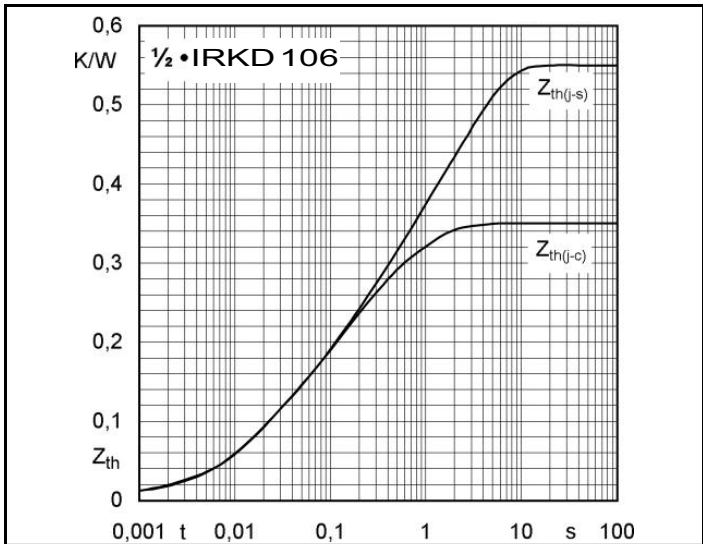

Fig. 14 Transient thermal impedance vs. time

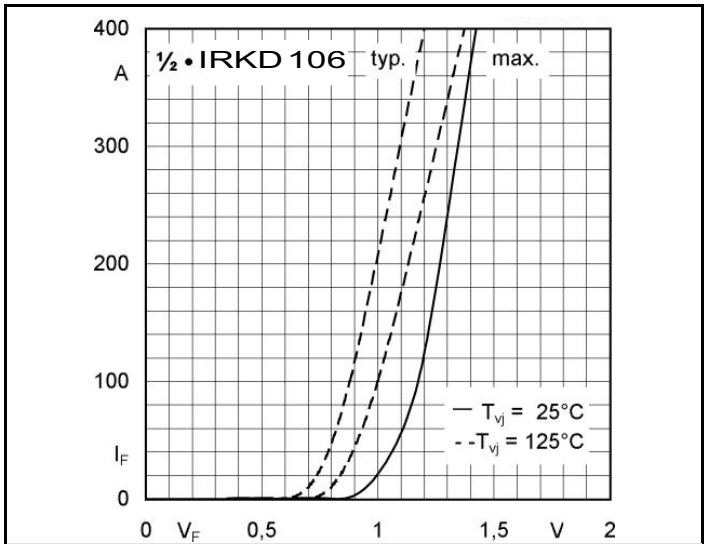

Fig. 15 Forward characteristics

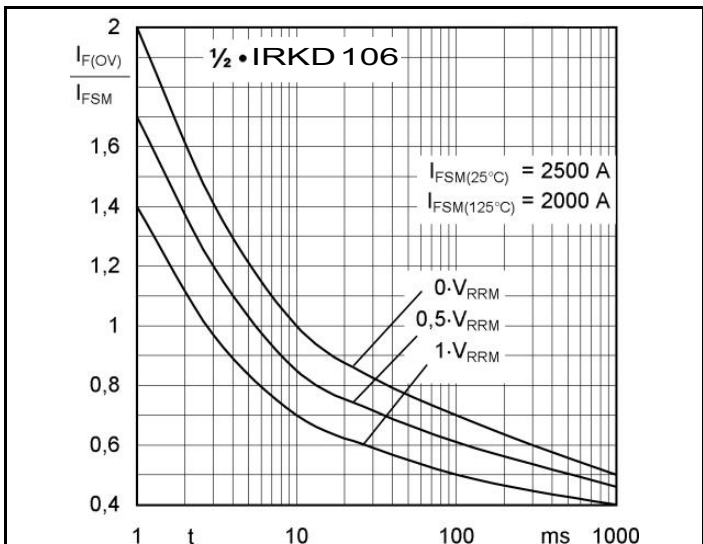
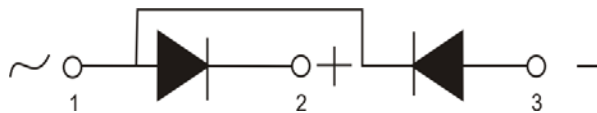

Fig. 16 Surge overload current vs. time

CIRCUIT DIAGRAM

IRKD 106



PACKAGE OUTLINE

IRKD 106

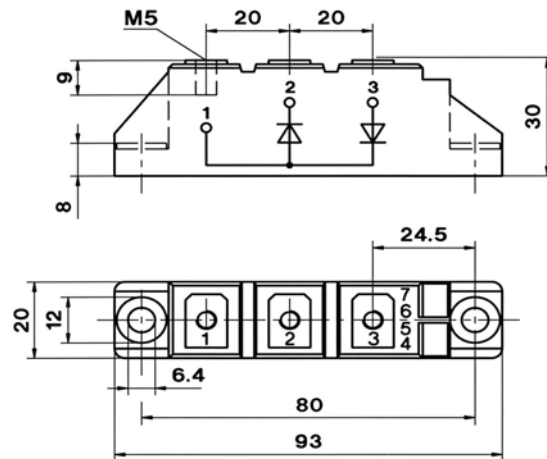

IR- 1

All dimensions are in mm.

Insel Rectifiers (India) Pvt. Ltd.

(An ISO 9001:2015, ISO 14001:2015 Certified Company)

Plot No 151, Udyog Kendra, Extn.-II, Ecotech-III, Greater Noida-201306

Toll Free No.: 1800 3070 9989, Fax : 011-27491404

E-mail : insel@rectifierindia.com, sales@rectifierindia.com