

FEATURES

- Wide current range
- High voltage ratings up to 4000 V
- High surge current capabilities
- Diffused junction
- Hockey PUK version

TYPICAL APPLICATIONS

- Converters
- Power supplies
- Machine tool controls
- High power drives
- Medium traction applications

TECHNICAL DATA

DEVICE TYPE	V_{RRM} (V)	V_{RSM} (V)
DS1107SG3636	3600	3700
DS1107SG3838	3800	3900
DS1107SG4040	4000	4100



CURRENT RATINGS

$T_{case} = 75^{\circ}C$ unless otherwise stated

Symbol	Parameter	Conditions	Max.	Units
Double Side Cooled				
$I_{F(AV)}$	Mean forward current	Half wave resistive load	1121	A
$I_{F(RMS)}$	RMS value	-	1761	A
I_F	Continuous (direct) forward current	-	1608	A
Single Side Cooled (Anode side)				
$I_{F(AV)}$	Mean forward current	Half wave resistive load	734	A
$I_{F(RMS)}$	RMS value	-	1154	A
I_F	Continuous (direct) forward current	-	989	A

$T_{case} = 100^{\circ}\text{C}$ unless otherwise stated

Symbol	Parameter	Conditions	Max.	Units
Double Side Cooled				
$I_{F(AV)}$	Mean forward current	Half wave resistive load	870	A
$I_{F(RMS)}$	RMS value	-	1366	A
I_F	Continuous (direct) forward current	-	1280	A
Single Side Cooled (Anode side)				
$I_{F(AV)}$	Mean forward current	Half wave resistive load	550	A
$I_{F(RMS)}$	RMS value	-	863	A
I_F	Continuous (direct) forward current	-	740	A

SURGE RATINGS

Symbol	Parameter	Conditions	Max.	Units
I_{FSM}	Surge (non-repetitive) forward current	10ms half sine; $T_{case} = 150^{\circ}\text{C}$	12.0	kA
I^2t	I^2t for fusing	$V_R = 50\% V_{RRM}$ - 1/4 sine	0.72×10^6	A^2s
I_{FSM}	Surge (non-repetitive) forward current	10ms half sine; $T_{case} = 150^{\circ}\text{C}$	15.0	kA
I^2t	I^2t for fusing	$V_R = 0$	1.125×10^6	A^2s

THERMAL AND MECHANICAL DATA

Symbol	Parameter	Conditions	Min.	Max.	Units	
$R_{th(j-c)}$	Thermal resistance - junction to case	Double side cooled	dc	-	0.032	$^{\circ}\text{C/W}$
		Single side cooled	Anode dc	-	0.064	$^{\circ}\text{C/W}$
			Cathode dc	-	0.064	$^{\circ}\text{C/W}$
$R_{th(c-h)}$	Thermal resistance - case to heatsink	Clamping force 12.0kN with mounting compound	Double side	-	0.008	$^{\circ}\text{C/W}$
			Single side	-	0.016	$^{\circ}\text{C/W}$
T_{vj}	Virtual junction temperature	Forward (conducting)	-	160	$^{\circ}\text{C}$	
		Reverse (blocking)	-	150	$^{\circ}\text{C}$	
T_{stg}	Storage temperature range		-55	175	$^{\circ}\text{C}$	
-	Clamping force		11.5	13.5	kN	

CHARACTERISTICS

Symbol	Parameter	Conditions	Min.	Max.	Units
V_{FM}	Forward voltage	At 1800A peak, $T_{case} = 25^{\circ}C$	-	1.6	V
I_{RRM}	Peak reverse current	At V_{RRM} , $T_{case} = 150^{\circ}C$	-	50	mA
Q_S	Total stored charge	$I_F = 1000A$, $dI_{RR}/dt = 3A/\mu s$ $T_{case} = 150^{\circ}C$, $V_R = 100V$	-	2000	μC
I_{rr}	Reverse recovery current		-	80	A
V_{TO}	Threshold voltage	At $T_{vj} = 150^{\circ}C$	-	0.75	V
r_T	Slope resistance	At $T_{vj} = 150^{\circ}C$	-	0.44	$m\Omega$

CURVES

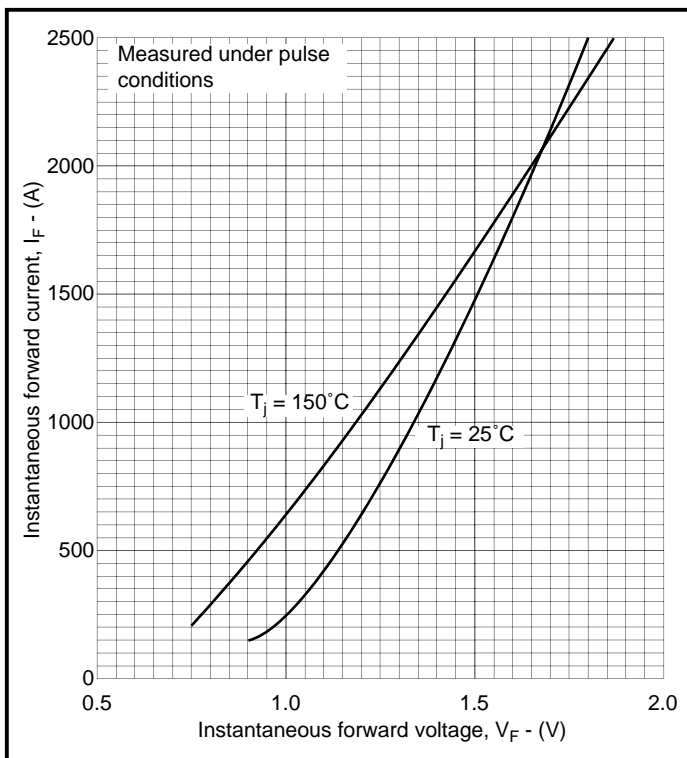

Fig.2 Maximum (limit) forward characteristics

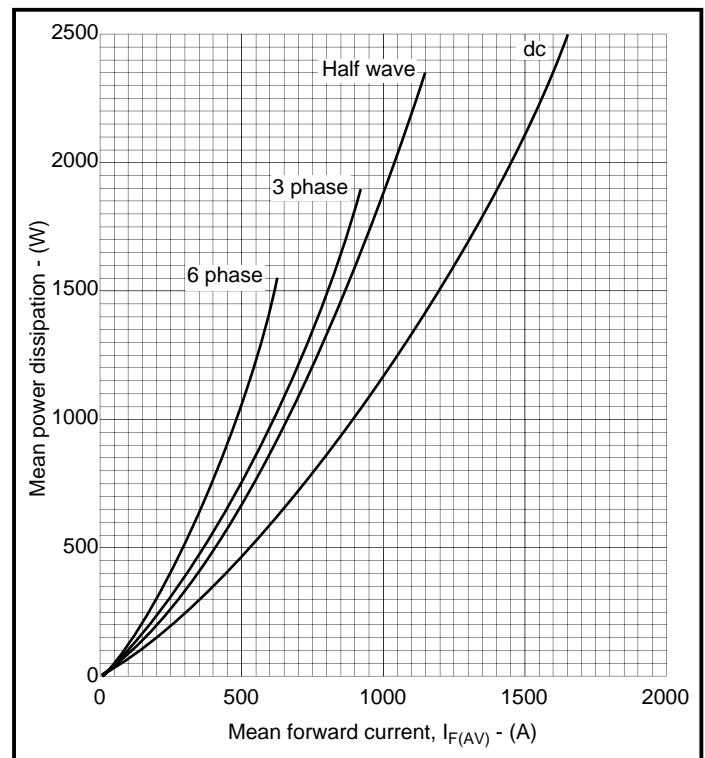

Fig.3 Dissipation curves

V_{FM} Equation:-

$$V_{FM} = A + B \ln(I_F) + C \cdot I_F + D \cdot \sqrt{I_F}$$

Where

A = 0.616461

B = -0.01452

C = 0.000349

D = 0.009952

these values are valid for $T_j = 125^{\circ}C$ for I_F 500A to 2500A

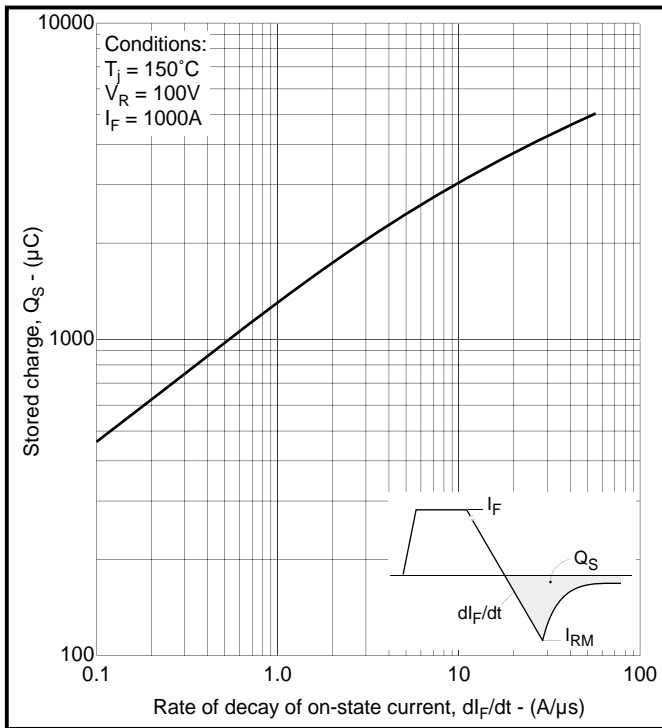

Fig.4 Total stored charge

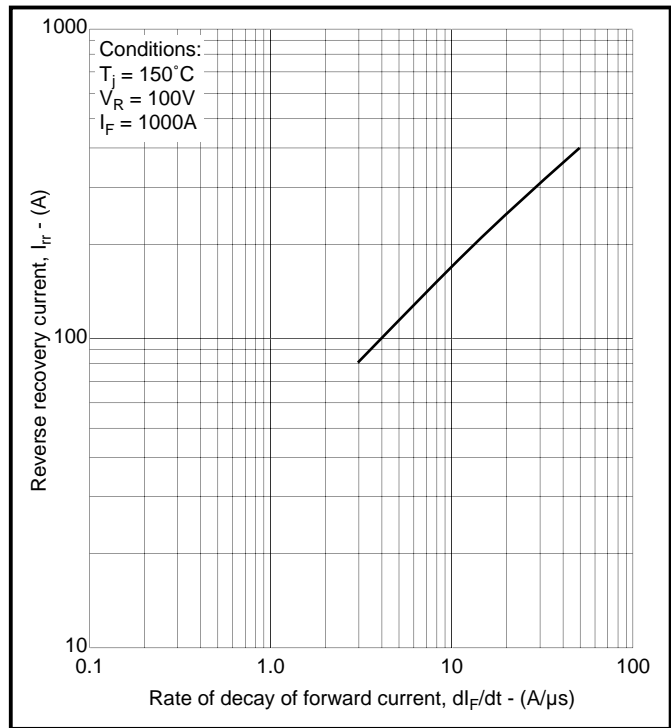

Fig.5 Maximum reverse recovery current

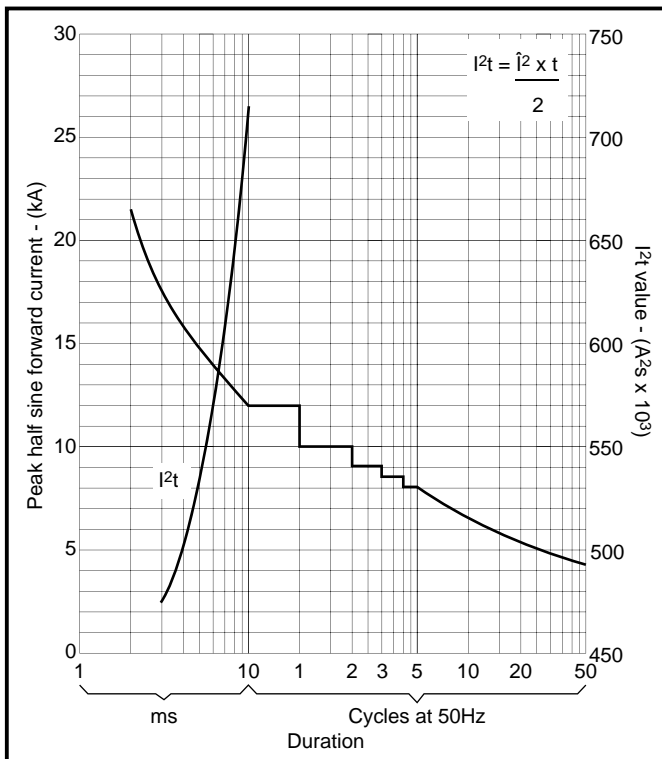

Fig.6 Surge (non-repetitive) forward current vs time (with 50% V_{RRM} at $T_{case} = 150^\circ\text{C}$)

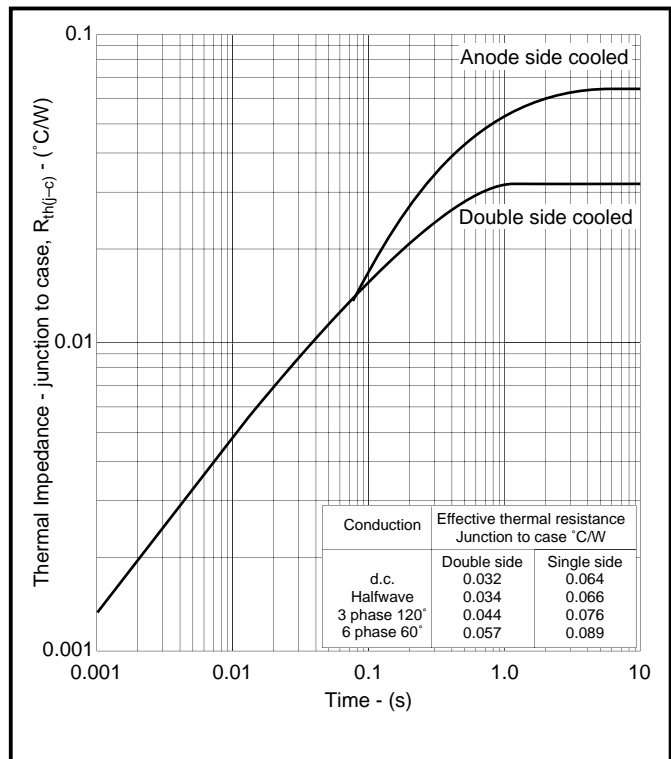
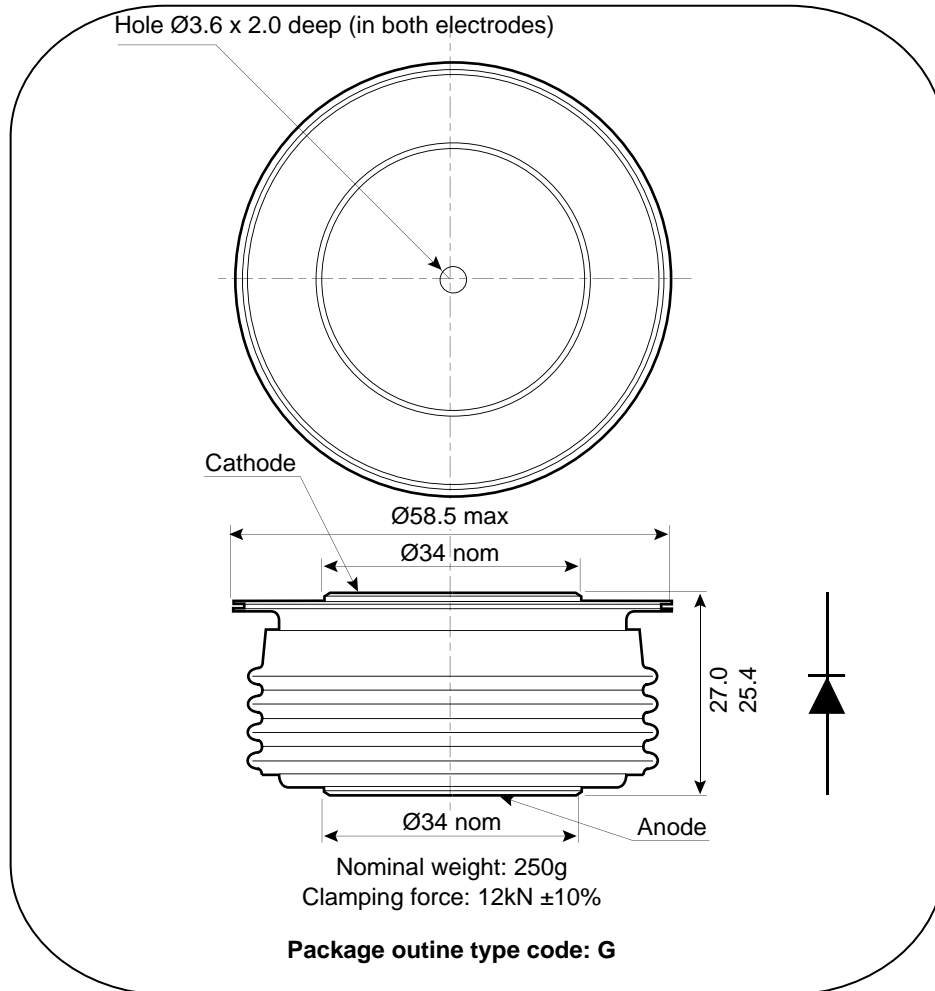

Fig.7 Maximum (limit) transient thermal impedance - junction to case

PACKAGE OUTLINE



All dimensions are in mm.

Insel Rectifiers (India) Pvt. Ltd.

(An ISO 9001:2015, ISO 14001:2015 Certified Company)

Plot No 151, Udyog Kendra, Extn.-II, Ecotech-III, Greater Noida-201306

Toll Free No.: 1800 3070 9989, Fax : 011-27491404

E-mail : insel@rectifierindia.com, sales@rectifierindia.com